

**ANANT**<sup>®</sup>  
**PRICE LIST**  
DATED : 09/04/2026



**ANANT TOOLS PVT. LTD.**

POST BOX. NO. 467

Regd. Office : A-1 Focal Point, Jalandhar-144 004 (INDIA)

Ph. : +91-181-5020570, 5020576

## ANANT IRON BODIED BENCH PLANES



**Regular Series**



**Prime Series**



**Brass Series**

\* with Brass Nut

**Description** ANANT Planes are made in comprehensive range of patterns and sizes suitable for different purposes. They embody many notable improvements and are produced with great care and accuracy.

The cut irons in all ANANT Adjustable Planes are made of high Carbon Steel.

The cut iron is hardened and tempered under scientific control ensuring accuracy and uniformity. It is precision ground all over, and is tested and guaranteed to be right temper.

The body is ribbed to ensure strength and rigidity. The machined faces of the frog bed firmly on to similar machined faces on the body and are securely fastened in position by two frog screws which in effect makes the frog solid with the body and prevents chattering.

The parts for adjusting the cut iron are accurately made to give very fine adjustment.

The handle and knob are of selected hardwood / high quality plastic and are fastened to the body by steel studs with steel cap nuts.

| Plane No.                          | Type    | Length                         |     | Width of Cutter               |    | Approx. Weight                |        | Unit Packing | Price per Piece | Price per Piece with Brass Nut |
|------------------------------------|---------|--------------------------------|-----|-------------------------------|----|-------------------------------|--------|--------------|-----------------|--------------------------------|
|                                    |         | inches                         | mm  | inches                        | mm | pounds                        | grams. |              |                 |                                |
| <b>A3</b>                          | Smooth  | 9 <sup>1</sup> / <sub>2</sub>  | 235 | 1 <sup>3</sup> / <sub>4</sub> | 45 | 3 <sup>1</sup> / <sub>2</sub> | 1300   | 12           | 889.00          | 910.00                         |
| <b>A4</b>                          | Smooth  | 9 <sup>3</sup> / <sub>4</sub>  | 250 | 2                             | 50 | 4                             | 1500   | 12           | 902.00          | 924.00                         |
| <b>A4<sup>1</sup>/<sub>2</sub></b> | Smooth  | 10 <sup>1</sup> / <sub>2</sub> | 265 | 2 <sup>3</sup> / <sub>8</sub> | 60 | 5 <sup>1</sup> / <sub>2</sub> | 1950   | 12           | 1178.00         | 1199.00                        |
| <b>A5</b>                          | Jack    | 14                             | 355 | 2                             | 50 | 5                             | 1850   | 12           | 1188.00         | 1210.00                        |
| <b>A5<sup>1</sup>/<sub>2</sub></b> | Jack    | 15 <sup>1</sup> / <sub>2</sub> | 380 | 2 <sup>3</sup> / <sub>8</sub> | 60 | 6                             | 2240   | 12           | 1447.00         | 1469.00                        |
| <b>A6</b>                          | Fore    | 18                             | 455 | 2 <sup>3</sup> / <sub>8</sub> | 60 | 7 <sup>1</sup> / <sub>2</sub> | 2800   | 6            | 1558.00         | 1577.00                        |
| <b>A7</b>                          | Jointer | 22                             | 560 | 2 <sup>3</sup> / <sub>8</sub> | 60 | 8                             | 3000   | 6            | 2331.00         | 2352.00                        |
| <b>A8</b>                          | Jointer | 24                             | 610 | 2 <sup>5</sup> / <sub>8</sub> | 66 | 9                             | 3350   | 6            | 2752.00         | 2773.00                        |

### Materials

Body, Frog and Lever Cap : High grade cast iron.

Cut Iron : High carbon steel.

Cap Iron : Best quality steel.

Handle and Knob : Selected hardwood / High quality Plastic

### Finish

Body and Frog : Stove enameled ANANT blue. Base and sides of body ground and polished.

Lever Cap : Plated.

### Packing

Individually cartoned.

### PRIME SERIES

| Plane No.                           | Type    | Length                         |     | Width of Cutter               |    | Approx. Weight                |        | Unit Packing | Price per Piece |
|-------------------------------------|---------|--------------------------------|-----|-------------------------------|----|-------------------------------|--------|--------------|-----------------|
|                                     |         | inches                         | mm  | inches                        | mm | pounds                        | grams. |              |                 |
| <b>AA3</b>                          | Smooth  | 9 <sup>1</sup> / <sub>2</sub>  | 235 | 1 <sup>3</sup> / <sub>4</sub> | 45 | 3 <sup>1</sup> / <sub>2</sub> | 1300   | 12           | 954.00          |
| <b>AA4</b>                          | Smooth  | 9 <sup>3</sup> / <sub>4</sub>  | 250 | 2                             | 50 | 4                             | 1500   | 12           | 964.00          |
| <b>AA4<sup>1</sup>/<sub>2</sub></b> | Smooth  | 10 <sup>1</sup> / <sub>2</sub> | 265 | 2 <sup>3</sup> / <sub>8</sub> | 60 | 5 <sup>1</sup> / <sub>2</sub> | 1950   | 12           | 1233.00         |
| <b>AA5</b>                          | Jack    | 14                             | 355 | 2                             | 50 | 5                             | 1850   | 12           | 1242.00         |
| <b>AA5<sup>1</sup>/<sub>2</sub></b> | Jack    | 15 <sup>1</sup> / <sub>2</sub> | 380 | 2 <sup>3</sup> / <sub>8</sub> | 60 | 6                             | 2240   | 12           | 1511.00         |
| <b>AA6</b>                          | Fore    | 18                             | 455 | 2 <sup>3</sup> / <sub>8</sub> | 60 | 7 <sup>1</sup> / <sub>2</sub> | 2800   | 6            | 1616.00         |
| <b>AA7</b>                          | Jointer | 22                             | 560 | 2 <sup>3</sup> / <sub>8</sub> | 60 | 8                             | 3000   | 6            | 2435.00         |
| <b>AA8</b>                          | Jointer | 24                             | 610 | 2 <sup>5</sup> / <sub>8</sub> | 66 | 9                             | 3350   | 6            | 2859.00         |

**Multi-Plane No. A45**

**Description**

The ANANT Multi - Planes, as its name implies, will perform a wide range of planing operations required by the cabinet maker and joiner, consisting of :

- 1. Ploughing
- 2. Dadoing
- 3. Beading
- 4. Centre Beading
- 5. Rabbeting and Fillistering
- 6. Match Planning
- 7. Sash Planning
- 8. Slitting

The many outstanding features of the ANANT multi - plane include : screw adjustment to cut iron, also to fence and depth gauge, two sets of fence arms (long and short), beading stop, slitting cutter, sliding section depth gauge, cam steady, and spurs for cross grain work.

23 Cut Irons are supplied with the planes as standard equipment. A comprehensive instruction booklet supplied with each plane.



**Materials**

Body and sliding section : High grade cast iron.

Cut iron : High carbon steel.

Fence : Cast iron with wood face, Handle and Knob selected hardwood / high quality plastic.

**Packing**

Individually packed in a varnished wooden box.

Length 10<sup>7</sup>/<sub>8</sub>" (277mm), Approx. weight 10 pounds (4.54 kg).

Spare cut irons and parts are readily available.

**Finish**

Plated all over.

| Plane No.  | Length |     | Unit Packing | Price per Piece | Price of Spare Cut Iron per set |
|------------|--------|-----|--------------|-----------------|---------------------------------|
|            | inches | mm  |              |                 |                                 |
| <b>A45</b> | 10     | 250 | 3            | 10308.00        | 2080.00                         |



**Plough Plane No. A52**

**Description**

ANANT Plough Plane will plough nine sizes of grooves from 1/8 inch (3 mm) to 5/8 inch (16 mm) in width to a depth of 5/8 inch (16 mm) at any distant from the edge of the work upto 5 inches (127 mm).

9 Standard plough cut irons supplied with each plane. Screw adjustment ensures accurate and easy control of the cut iron whilst the cut iron clamping screw prevents lateral movement of the cut iron. Each plane is fitted with an adjustable depth gauge, a double arm adjustable bridge fence and two pairs of fence arms (long and short). The fence may be used as either side of plane.

**Materials**

Body and sliding section : High grade cast iron.

Cut iron : High carbon steel.

**Finish**

CHROME Plated all over.

**Packing**

Individually cartoned

9 standard cut irons are supplied with this plane.

1/8" 3/16" 1/4" 5/16" 3/8" 7/16" 1/2" 9/16" 5/8"

| Plane No.  | Length |     | Unit Packing | Price per Piece | Price of Spare Cut Iron per set |
|------------|--------|-----|--------------|-----------------|---------------------------------|
|            | inches | mm  |              |                 |                                 |
| <b>A52</b> | 7 3/8  | 200 | 10           | 2470.00         | 988.00                          |



## Block Plane No. A 9 1/2

### Description

The plane is fully adjustable and capable of fine accurate work. The screw adjusted cut iron is held firmly in position by a lever and cam and the mouth is adjustable for fine or coarse work.

### Materials

Body and Lever Cap: High grade cast iron.  
Cut Iron : High carbon steel.

### Finish

Stove enamelled ANANT blue. Base and sides of body ground and polished.

**Packing** : Individually cartoned.

| Plane No.     | Length |     | Width of Cut Iron |    | Unit Packing | Price per Piece | Price of Spare Cut Iron per Doz |
|---------------|--------|-----|-------------------|----|--------------|-----------------|---------------------------------|
|               | inches | mm  | inches            | mm |              |                 |                                 |
| <b>A9 1/2</b> | 6      | 153 | 1 5/8             | 40 | 36           | 945.00          | 1700.00                         |

### PRIME SERIES

|                |   |     |       |    |    |         |         |
|----------------|---|-----|-------|----|----|---------|---------|
| <b>AA9 1/2</b> | 6 | 153 | 1 5/8 | 40 | 36 | 1007.00 | 1700.00 |
|----------------|---|-----|-------|----|----|---------|---------|

### Description

This plane has two mouths, the illustration showing the cut iron in its normal position. Both the cut iron and lever cap may be reversed to form bull nose plane. Cut iron is tightened in position by a knurled wheel and screw.

### Materials

Body and Lever Cap : High grade cast iron.  
Cut Iron : High carbon steel.

### Finish

Stove enamelled ANANT blue. Base and sides of body ground and polished.

### Packing

Individually cartoned.

| Plane No.   | Length |     | Width of Cut Iron |    | Unit Packing | Price per Piece | Price of Spare Cut Iron per Doz | Price per Piece with Metal Nut |
|-------------|--------|-----|-------------------|----|--------------|-----------------|---------------------------------|--------------------------------|
|             | inches | mm  | inches            | mm |              |                 |                                 |                                |
| <b>A130</b> | 7 3/8  | 197 | 1 5/8             | 40 | 30           | 565.00          | 997.00                          | 586.00                         |

### PRIME SERIES

|              |       |     |       |    |    |        |        |  |
|--------------|-------|-----|-------|----|----|--------|--------|--|
| <b>AA130</b> | 7 3/8 | 197 | 1 5/8 | 40 | 30 | 581.00 | 997.00 |  |
|--------------|-------|-----|-------|----|----|--------|--------|--|

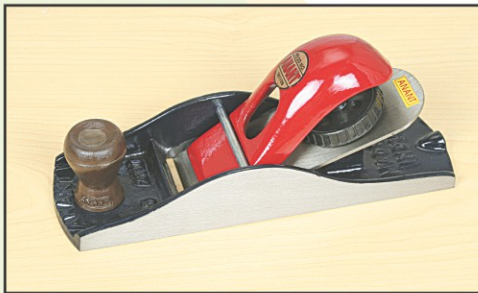

\* with Metal Nut

## Block Plane No. A 130



\* with Metal Nut

## Block Plane No. A 110

A general purpose block plane the cut iron of which is rigidly held by a knurled wheel and screw. A hardwood/plastic front knob is fitted.

### Description

The ANANT block plane is handy, easy to use tool, mainly used when planing and grain, its use extending to many other planing jobs.

### Materials

Body and Lever Cap : High grade cast iron.  
Cut Iron : High carbon steel.

### Finish

Stove enamelled ANANT blue. Base and sides of body ground and polished.

**Packing** : Individually cartoned.

| Plane No.   | Length |     | Width of Cut Iron |    | Unit Packing | Price per Piece | Price of Spare Cut Iron per Doz | Price per Piece with Metal Nut |
|-------------|--------|-----|-------------------|----|--------------|-----------------|---------------------------------|--------------------------------|
|             | inches | mm  | inches            | mm |              |                 |                                 |                                |
| <b>A110</b> | 7      | 178 | 1 5/8             | 42 | 48           | 446.00          | 997.00                          | 465.00                         |

### PRIME SERIES

|              |   |     |       |    |    |        |        |  |
|--------------|---|-----|-------|----|----|--------|--------|--|
| <b>AA110</b> | 7 | 178 | 1 5/8 | 42 | 48 | 468.00 | 997.00 |  |
|--------------|---|-----|-------|----|----|--------|--------|--|

**Block Plane No. A 102**

A light block plane suitable for straight forward work where frequent adjustment is not essential.

**Description**

The ANANT Block Plane is a handy, easy to use tool, mainly used when planing and grain, its use extending to many other small planing jobs.

**Materials**

Body and Lever Cap : High grade cast iron.  
Cut Iron : High carbon steel.

**Finish**

Stove enamelled ANANT blue. Base and sides of body ground and polished.

**Packing**

Individually cartoned.



| Plane No.   | Length |     | Width of Cut Iron |    | Unit Packing | Price per Piece | Price of Spare Cut Iron per Doz | Price per Piece with Metal Nut |
|-------------|--------|-----|-------------------|----|--------------|-----------------|---------------------------------|--------------------------------|
|             | inches | mm  | inches            | mm |              |                 |                                 |                                |
| <b>A102</b> | 5 1/2  | 140 | 1 3/8             | 35 | 60           | 417.00          | 919.00                          | 438.00                         |

**PRIME SERIES**

|              |       |     |       |    |    |        |        |
|--------------|-------|-----|-------|----|----|--------|--------|
| <b>AA102</b> | 5 1/2 | 140 | 1 3/8 | 35 | 60 | 436.00 | 919.00 |
|--------------|-------|-----|-------|----|----|--------|--------|



**RABBET PLANE NO. A39**

**Description**

The plane has an angular cut iron seat for a secure and smooth cut is provided with screw adjustable depth gauge.

**Materials:** Body : High grade cast iron. **Finish** : Stove enamelled ANANT blue.  
Cut Iron : High carbon steel. **Packing** : Individually cartoned.

| Plane No.  | Length |     | Width of Cut Iron |    | Unit Packing | Price per Piece | Price of Spare Cut Iron per Doz |
|------------|--------|-----|-------------------|----|--------------|-----------------|---------------------------------|
|            | inches | mm  | inches            | mm |              |                 |                                 |
| <b>A39</b> | 8      | 200 | 1/2               | 12 | 36           | 1024.00         | 1296.00                         |

**Bench Rabbet Plane No. A10**

**Description**

These planes are recommended for general rabbeting work where a heavy section is being cut. The planes are fitted with normal adjustments to the cut irons.

**Materials**

Body, Frog : High grade cast iron.  
Cut Iron : High carbon steel.  
Handle and knob : Selected hardwood / High quality plastic.

**Finish**

Body and frog : Stove enamelled ANANT blue.  
Base and sides of body ground and polished.  
Lever cap and screw : Plated

**Packing**

Individually cartoned.



| Plane No.  | Length |     | Width of Cut Iron |    | Unit Packing | Price per Piece | Price of Spare Cut Iron per Doz |
|------------|--------|-----|-------------------|----|--------------|-----------------|---------------------------------|
|            | inches | mm  | inches            | mm |              |                 |                                 |
| <b>A10</b> | 13     | 330 | 2                 | 43 | 12           | 1488.00         | 1780.00                         |

**PRIME SERIES**

|             |    |     |   |    |    |         |         |
|-------------|----|-----|---|----|----|---------|---------|
| <b>AA10</b> | 13 | 330 | 2 | 43 | 12 | 1553.00 | 1780.00 |
|-------------|----|-----|---|----|----|---------|---------|



## Circular Plane No. A113

### Description

The plane is designed for use of concave and convex surfaces. The flexible steel face is anchored at each end of the body of the plane and centre screw adjustment enables the desired curvature of the sole to be set quickly and positively. The frame is shaped to provide a comfortable grip at each end and the cut iron is fully adjustable being secured when set by a lever cap.

### Materials

Body : High grade cast iron.  
Cut Iron : High carbon steel.  
Face : High quality spring steel

### Finish

Body : Stove enamelled ANANT blue.  
Lever Cap : Plated

**Packing :** Individually cartoned.

| Plane No.   | Length |    | Unit Packing | Price per Piece | Price of Spare Cut Iron per Doz |
|-------------|--------|----|--------------|-----------------|---------------------------------|
|             | inches | mm |              |                 |                                 |
| <b>A113</b> | 10     | 45 | 12           | 5855.00         | 1430.00                         |

## Duplex Rabbet & Fillister Plane No. A78

### Description

The plane is designed to cut accurate rabbets and fillisters up to 1½" (38 mm) in width. Two cut iron positions are provided, the forward position for bull nose work and the rear position for normal rabbeting and fillistering. When used in the rear position, the cut iron is screw adjusted and is fed into the work with an accurate, positive and easy control.

A hardened steel spur is fitted to assist in rabbeting across the grain and the fully adjustable depth gauge is removable. The adjustable fence supplied may be used on either side of the plane and two fence arms simplify accurate setting and control. The base and sides are ground and polished.

### Materials

Body and fence : High grade cast iron.  
Cut Iron : High carbon steel.  
Knob : Selected hardwood / high quality plastic

### Finish

Stove enamelled ANANT blue. Base and sides of body ground and polished.

### Packing

Individually cartoned.



| Plane No.  | Length |     | Width of Cut Iron |    | Unit Packing | Price per Piece | Price of Spare Cut Iron per Doz |
|------------|--------|-----|-------------------|----|--------------|-----------------|---------------------------------|
|            | inches | mm  | inches            | mm |              |                 |                                 |
| <b>A78</b> | 8 1/2  | 216 | 1 1/2             | 38 | 12           | 1713.00         | 1764.00                         |

### PRIME SERIES

|             |       |     |       |    |    |         |         |
|-------------|-------|-----|-------|----|----|---------|---------|
| <b>AA78</b> | 8 1/2 | 216 | 1 1/2 | 38 | 12 | 1802.00 | 1764.00 |
|-------------|-------|-----|-------|----|----|---------|---------|



## Duplex Rabbet & Fillister Plane No. A078

### Description

Similar in operation to the No. A78, this plane will also cut rabbets and fillisters up to 1½" (38 mm) in width. With the cut iron in the forward position, the plane may be used for bull nose work and when in the rear position, adjustment to the cut iron is provided by a lever.

Fitted with a hardened steel spur for cross grain work and an adjustment gauge which can be removed from the plane if desired. The single arm adjustable fence supplied may be used on either side of the plane. Base and sides are ground and polished.

| Plane No.   | Length |     | Width of Cut Iron |    | Unit Packing | Price per Piece | Price of Spare Cut Iron per Doz |
|-------------|--------|-----|-------------------|----|--------------|-----------------|---------------------------------|
|             | inches | mm  | inches            | mm |              |                 |                                 |
| <b>A078</b> | 8 1/2  | 216 | 1 1/2             | 38 | 12           | 1350.00         | 1764.00                         |

### PRIME SERIES

|              |       |     |       |    |    |         |         |
|--------------|-------|-----|-------|----|----|---------|---------|
| <b>AA078</b> | 8 1/2 | 216 | 1 1/2 | 38 | 12 | 1414.00 | 1764.00 |
|--------------|-------|-----|-------|----|----|---------|---------|

### Materials

Body and fence : High grade cast iron.  
Cut Iron : High carbon steel.

### Finish

Stove enamelled ANANT blue. Base and sides of body ground and polished.

**Packing :** Individually cartoned.

**Bull Nose Rabbet Plane No. A77**

**Description**

The plane is designed for the fine work where extreme accuracy is required. An improved adjustable mouth has been embodied in this plane, two steel distance pieces between the detachable nose and the body providing four different mouth adjustments for fine or coarse work.

The plane can be converted to a chisel plane by removing the nose.

The depth of cut is regulated by screw adjustment of the cut iron. The base and sides are accurately machined and bright finished and the plane may be used on the either side.

**Materials**

Body, Nose and Lever Cap : High grade cast iron.

Cut Iron : High carbon steel.

**Finish**

Stove enamelled ANANT blue. Base and sides of body ground and polished.

**Packing :** Individually cartoned.



| Plane No.  | Length |     | Width of Cut Iron |    | Unit Packing | Price per Piece | Price of Spare Cut Iron per Doz |
|------------|--------|-----|-------------------|----|--------------|-----------------|---------------------------------|
|            | inches | mm  | inches            | mm |              |                 |                                 |
| <b>A77</b> | 4      | 102 | 1 1/8             | 29 | 36           | 1112.00         | 1348.00                         |



**Craftsman Plane No. A33**

**Description**

The plane is adjustable instantaneously by means of two knurled screws for depth of cut and cut iron alignment.

**Materials**

Body and lever cap : High grade cast iron.

Cut Iron : High carbon steel.

**Finish**

Stove enamelled ANANT blue. Base and sides of body ground and polished.

**Packing :** Individually cartoned.

| Plane No.  | Length |     | Width of Cut Iron |    | Unit Packing | Price per Piece | Price of Spare Cut Iron per Doz |
|------------|--------|-----|-------------------|----|--------------|-----------------|---------------------------------|
|            | inches | mm  | inches            | mm |              |                 |                                 |
| <b>A33</b> | 8 1/4  | 210 | 1 3/4             | 45 | 15           | 590.00          | 913.00                          |

**PRIME SERIES**

|             |       |     |       |    |    |        |        |
|-------------|-------|-----|-------|----|----|--------|--------|
| <b>AA33</b> | 8 1/4 | 210 | 1 3/4 | 45 | 15 | 630.00 | 913.00 |
|-------------|-------|-----|-------|----|----|--------|--------|

**Block Plane No. A 60 1/2**

**Description**

The ANANT block planes are made from accurately machined, fine grey iron. Unmachined surfaces are finished with a durable high gloss stoving enamel. Block planes are ideal for end grain work or any situation where single handed applications are required. The low angle fully supported cutter ensures that vibration is kept to a minimum, thus making for good performance on plastic laminates and other man-made materials.

Low angle cutters seats at 13 1/2 degrees. Fully adjustable for depth of cut, cutter alignment and size of mouth. Particularly effective on end grain and plastic laminates.

**Materials**

Body and Lever Cap : High grade cast grey iron.

Cut Iron : High grade carbon steel.

**Finish**

Stove enamelled ANANT black. Base and sides of body ground and polished.

**Packing**

Individually packed in carton box.



| Plane No.      | Length |     | Width of Cut Iron |    | Unit Packing | Price per Piece | Price of Spare Cut Iron per Doz |
|----------------|--------|-----|-------------------|----|--------------|-----------------|---------------------------------|
|                | inches | mm  | inches            | mm |              |                 |                                 |
| <b>A60 1/2</b> | 6      | 150 | 1 3/8             | 35 | 36           | 913.00          | 1462.00                         |

**PRIME SERIES**

|                 |   |     |       |    |    |        |         |
|-----------------|---|-----|-------|----|----|--------|---------|
| <b>AA60 1/2</b> | 6 | 150 | 1 3/8 | 35 | 36 | 953.00 | 1462.00 |
|-----------------|---|-----|-------|----|----|--------|---------|

# ANANT



## Block Plane No. A 220

### Description

The ANANT block planes are made from accurately machined, fine grey iron. Unmachined surfaces are finished with a durable high gloss stoving enamel. Block planes are ideal for end grain work or any situation where single handed applications are required. The low angle fully supported cutter ensures that vibration is kept to a minimum, thus making for good performance on plastic laminates and other man-made materials.

Fully adjustable for depth of cut iron and cutter alignment. Cutter seats at 21 degrees. Ideal for end grain and general purpose fine finishing. A general purpose adjustable block plane.

### Materials

Body and Lever Cap : High grade cast grey iron.  
Cut Iron : High grade carbon steel.

### Finish

Stove enamelled ANANT black. Base and sides of body ground and polished.

### Packing

Individually packed in carton box.

| Plane No.   | Length |     | Width of Cut Iron |    | Unit Packing | Price per Piece | Price of Spare Cut Iron per Doz |
|-------------|--------|-----|-------------------|----|--------------|-----------------|---------------------------------|
|             | inches | mm  | inches            | mm |              |                 |                                 |
| <b>A220</b> | 6 1/4  | 160 | 1 5/8             | 40 | 36           | 739.00          | 1272.00                         |

### PRIME SERIES

|              |       |     |       |    |    |        |         |
|--------------|-------|-----|-------|----|----|--------|---------|
| <b>AA220</b> | 6 1/4 | 160 | 1 5/8 | 40 | 36 | 770.00 | 1272.00 |
|--------------|-------|-----|-------|----|----|--------|---------|

## Block Plane No. A 60

### Description

The ANANT block planes are made from accurately machined, fine grey iron. Unmachined surfaces are finished with a durable high gloss stoving enamel. Block planes are ideal for end grain work or any situation where single handed applications are required. The low angle fully supported cutter ensures that vibration is kept to a minimum, thus making for good performance on plastic laminates and other man-made materials. Fully adjustable for depth of cut iron and cutter alignment. Cutter seats at 21 degrees. Ideal for end grain and general purpose fine finishing.

### Materials

Body and Lever Cap : High grade cast grey iron.  
Cut Iron : High grade carbon steel.

### Finish

Stove enamelled ANANT black. Base and sides of body ground and polished.

### Packing

Individually packed in carton box.



| Plane No.  | Length |     | Width of Cut Iron |    | Unit Packing | Price per Piece | Price of Spare Cut Iron per Doz |
|------------|--------|-----|-------------------|----|--------------|-----------------|---------------------------------|
|            | inches | mm  | inches            | mm |              |                 |                                 |
| <b>A60</b> | 7      | 180 | 1 5/8             | 40 | 36           | 545.00          | 842.00                          |

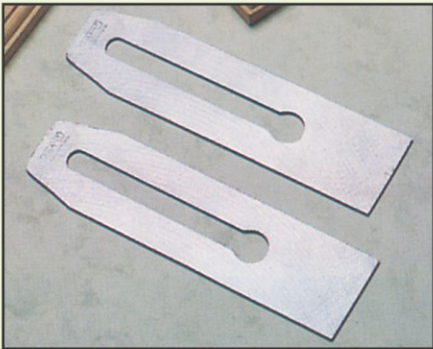

## Spare Cut Irons

### Description

The Cut Iron is of High Carbon Steel and is hardened and tempered under scientific control, which ensured accuracy and uniformity. It is precision ground all over, is tested and guaranteed to be the right temper.

### Packing

6 pieces in a box.

| Size   |    | Price per Doz. |
|--------|----|----------------|
| Inches | mm |                |
| 1 1/2" | 38 | 1384.00        |
| 1 3/4" | 45 | 1491.00        |
| 2"     | 50 | 1491.00        |
| 2 1/4" | 57 | 1935.00        |
| 2 3/8" | 60 | 1936.00        |
| 2 5/8" | 66 | 2135.00        |

## Spokeshaves

### Description

The Spokeshave is a handy shaping tool useful for small curves, furniture legs, etc; and provides a smooth plane-like finish. The wide range of spokeshaves caters for every requirement and is produced in two different types, (a) with flat face for use on convex curves, and (b) with round face for use on concave curves. The choice of raised and flat handles is a matter of personal preferences. All are fitted with double iron and the combined cap iron and lever cap being secured either by means of thumb screw or knurled screw according to type.

### Materials

Body : Nos. A151, A151R, A51, A51R, A63, A64, High grade malleable iron.

Guaranteed against breakage.

Nos. 0151, 0151R, 051 and 051R High grade cast iron.

Cut Iron : High Carbon Steel

### Finish

Stove enamelled, Malleable iron red, Cast iron ANANT Blue.

### Packing

Individually cartoned. 051, 051R, 0151, 0151R, A51, A51R, A151, A151R four per master carton and A63 six per master carton.

No. 0151 Flat Face, No. 0151R Round Face  
Raised Handle, Cast Iron Body.

No. A151 Flat Face, No. A151R Round Face  
Raised Handle, Malleable Iron Body.

No. A63 Round Face  
Straight Handle, Malleable Iron Body.



No. 0151 Flat Face, No. 0151R Round Face  
Adjustable cut iron, Raised Handle Cast Iron Body.

No. A151 Flat Face, No. A151R Round Face  
Adjustable cut iron, Raised Handle Malleable Iron Body.

No. A64 Flat Face  
Straight Handle, Malleable Iron Body.



### PRIME SERIES

| No.           | Length |     | Width of Cut Iron |    | Unit Packing | Price per Piece | Price of Spare Cut Iron per Doz |
|---------------|--------|-----|-------------------|----|--------------|-----------------|---------------------------------|
|               | inches | mm  | inches            | mm |              |                 |                                 |
| <b>051</b>    | 10     | 250 | 2 1/8             | 54 | 72           | 283.00          | 724.00                          |
| <b>051R</b>   | 10     | 250 | 2 1/8             | 54 | 72           | 283.00          | 724.00                          |
| <b>0151</b>   | 10     | 250 | 2 1/8             | 54 | 72           | 338.00          | 811.00                          |
| <b>0151R</b>  | 10     | 250 | 2 1/8             | 54 | 72           | 338.00          | 811.00                          |
| <b>A 51</b>   | 10     | 250 | 2 1/8             | 54 | 72           | 338.00          | 724.00                          |
| <b>A 51R</b>  | 10     | 250 | 2 1/8             | 54 | 72           | 338.00          | 724.00                          |
| <b>A 151</b>  | 10     | 250 | 2 1/8             | 54 | 72           | 396.00          | 811.00                          |
| <b>A 151R</b> | 10     | 250 | 2 1/8             | 54 | 72           | 396.00          | 811.00                          |
| <b>A 64</b>   | 9      | 210 | 1 3/4             | 45 | 144          | 283.00          | 724.00                          |
| <b>A 63</b>   | 9      | 210 | 1 3/4             | 45 | 144          | 283.00          | 724.00                          |

| No.            | Price per Piece | Price of Spare Cut Iron per Doz |
|----------------|-----------------|---------------------------------|
| <b>0051</b>    | 295.00          | 724.00                          |
| <b>0051R</b>   | 295.00          | 724.00                          |
| <b>00151</b>   | 352.00          | 811.00                          |
| <b>00151R</b>  | 352.00          | 811.00                          |
| <b>AA 51</b>   | 352.00          | 724.00                          |
| <b>AA 51R</b>  | 352.00          | 724.00                          |
| <b>AA 151</b>  | 411.00          | 811.00                          |
| <b>AA 151R</b> | 411.00          | 811.00                          |
| <b>AA 64</b>   | 295.00          | 724.00                          |
| <b>AA 63</b>   | 295.00          | 724.00                          |

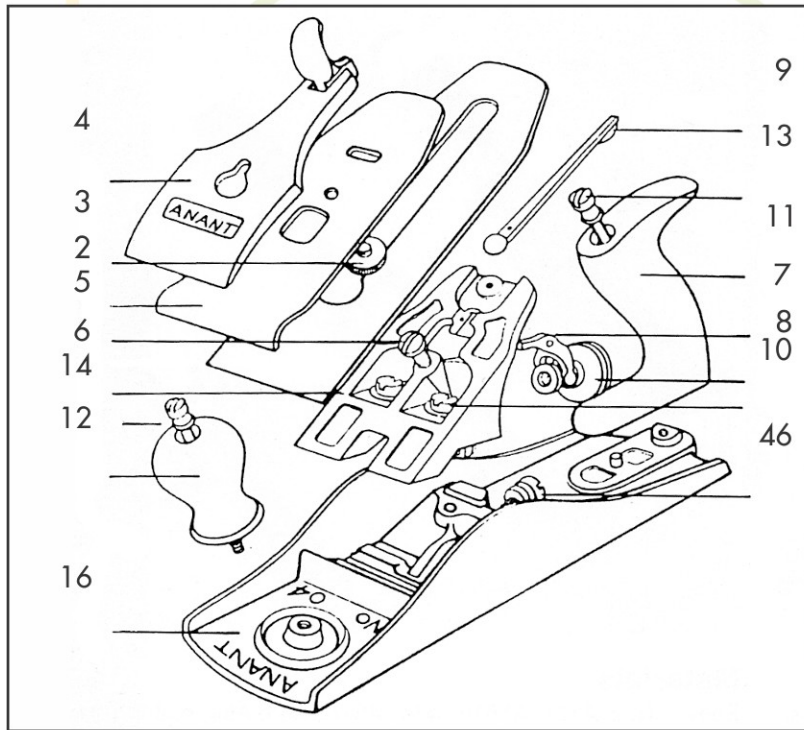

### Prices of Spares

| No.   | Name of Part            | Price per Pc. |        |         |        |              |           |
|-------|-------------------------|---------------|--------|---------|--------|--------------|-----------|
|       |                         | A 3           | A 4    | A 4 1/2 | A 5    | A5 1/2 & A 6 | A 7 & A 8 |
| 2     | Cap                     | 54.00         | 54.00  | 70.00   | 54.00  | 70.00        | 70.00     |
| 3     | Cap Screw               | 23.00         | 23.00  | 23.00   | 23.00  | 23.00        | 23.00     |
| 4     | Lever                   | 86.00         | 86.00  | 99.00   | 86.00  | 99.00        | 99.00     |
| 5     | Lever Screw             | 22.00         | 22.00  | 22.00   | 22.00  | 22.00        | 22.00     |
| 6     | Frog Complete           | 253.00        | 253.00 | 331.00  | 253.00 | 331.00       | 464.00    |
| 7     | 'Y' Adjusting Lever     | 28.00         | 28.00  | 28.00   | 28.00  | 28.00        | 28.00     |
| 8     | Adjusting Nut           | 74.00         | 74.00  | 74.00   | 74.00  | 74.00        | 74.00     |
| 8 1/2 | Adjusting Nut Screw     | 23.00         | 23.00  | 23.00   | 23.00  | 23.00        | 23.00     |
| 9     | Lateral Adjusting Lever | 28.00         | 28.00  | 28.00   | 28.00  | 28.00        | 28.00     |
| 10    | Frog Screw & Washer     | 18.00         | 18.00  | 18.00   | 18.00  | 18.00        | 18.00     |
| 11    | Plane Handle            | 84.00         | 84.00  | 84.00   | 84.00  | 84.00        | 84.00     |
| 12    | Plane Knob              | 62.00         | 62.00  | 62.00   | 62.00  | 62.00        | 62.00     |
| 13    | Handle Bolt & Nut       | 33.00         | 33.00  | 33.00   | 33.00  | 33.00        | 33.00     |
| 14    | Knob Bolt & Nut         | 23.00         | 23.00  | 23.00   | 23.00  | 23.00        | 23.00     |
| 15    | Handle Toe Screw        | 13.00         | 13.00  | 13.00   | 13.00  | 13.00        | 13.00     |
| 16    | Plane Bottom            | 338.00        | 338.00 | 364.00  | 424.00 | 757.00       | 1133.00   |
| 17    | Frog Clip & Screw       | 22.00         | 22.00  | 22.00   | 22.00  | 22.00        | 22.00     |
| 46    | Frog Adjusting Screw    | 22.00         | 22.00  | 22.00   | 22.00  | 22.00        | 22.00     |

While placing orders please be sure to specify name of part, its number & number of plane/planes for which required, PRICES NETT. An order for the LEVER part is restricted to three pcs. only.

**Anant Sheet Plane No. 33A**

**Description**

Joinery Planer 33A Metal is used for finishing manual planing of wood of various species, as well as for planing the ends of blanks or ends of parts in assembled products (frames, boxes etc.)

**Body Description:**

Cutter Width : 45MM  
Planner Length : 250MM

**Blade Material :**

High Carbon Steel.



| No.        | Price per Piece |
|------------|-----------------|
| <b>33A</b> | 385.00          |



**Anant Sheet Plane No. 33B**

**Description**

No. 33B Steel Planer with adjustable blade made on high-precision equipment provides high quality finishing of the surface features.

The blade of the planer is made of high quality tool steel hardened and tempered to HRC 55-63.

**Body Description:**

Cutter Width : 45MM  
Planner Length : 250MM

**Blade Material :**

High Quality Tool Steel.

| No.        | Price per Piece |
|------------|-----------------|
| <b>33B</b> | 431.00          |

**Anant Sheet Plane No. 102**

**Description**

This professional tool is used for finishing manual planing of wood of various species, as well as for planing the ends of blanks or ends of parts in assembled products (frames, boxes etc.)

**Body Description:**

Planner Size : 135x40MM  
Cutter Width : 35MM

**Blade Material :**

High Carbon Steel.



| No.        | Price per Piece |
|------------|-----------------|
| <b>102</b> | 158.00          |

# ANANT

## T-Bar Clamp, Steel Sash Clamp & Extension Bar



### T-Bar Clamp

Bar Section - Final Machine Scale  
 No. A 136, 1 3/4", 3/4" (45mm x 19mm)

### Description

The bars of these clamps are made of special T-Bar section steel and will not bend in use. The T edges on which the slides operate are dimensionally accurate ensuring an easy sliding movement. Head and slides are robustly designed to match the strength of the bar.

The ANANT improved working slide, which incorporates large thrust surfaces ensure long wear and a reliable coupling between slide and screw.

Lengthening bars are available. (See Table)

### Materials

Bar : Cold rolled steel T-Bar section.  
 Head and slides : SG Iron  
 Screw and Handle : High Quality Steel

### Finish

Enamelled ANANT Blue.

Spare parts are readily available.

| Size   | Price per Piece |
|--------|-----------------|
| 3'     | 1408.00         |
| 3 1/2' | 1500.00         |
| 4      | 1626.00         |
| 4 1/2' | 1731.00         |
| 5      | 1850.00         |
| 5 1/2' | 1980.00         |
| 6      | 2104.00         |

### Extension Bar

| Size   | Price per Piece |
|--------|-----------------|
| 2'     | 783.00          |
| 2 1/2' | 857.00          |
| 3'     | 970.00          |
| 3 1/2' | 1077.00         |
| 4'     | 1186.00         |
| 4 1/2' | 1291.00         |

### Steel Sash Clamp

Bar Section - Final Machine Scale  
 Left: No. A 135, 1 1/4", 1/4" (32mm x 7mm)

### Description

These clamps are fitted with the ANANT improved working slide, the principle feature of which is the incorporation of large thrust surfaces ensuring long wear and providing a reliable coupling between slide and screw. Each clamp is fitted with a bar stop to prevent accidental loss of the tail slide.

Lengthening bars are available. (See Table)

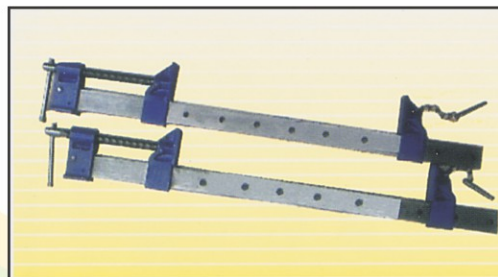

### Materials

Bar : Bright steel with square edges.  
 Head and Slides : SG Iron  
 Screw and Handle : High Quality Steel

### Finish

Bar : Bright polished.  
 Head and Slides : Enamelled ANANT Blue.  
 Spare parts are readily available.

| Size | Price per Piece |
|------|-----------------|
| 3'   | 1031.00         |
| 4'   | 1183.00         |
| 5'   | 1364.00         |
| 6'   | 1580.00         |

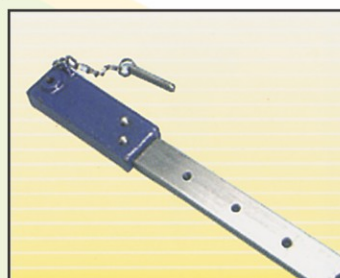

**Pipe/Gluing Clamp 1/2"**

**Description**

1/2" Heavy Duty Wood Gluing Pipe Clamp with quick release Carpenter Hand Tool. Easy to operate clamping force, sturdy and durable structure is simple, Spring lever control locks jaw at any needed location and provides quick release.

**Materials :**

Special Graded Iron.

**Fitting Pipe Size : 1/2"**

**Color:**

ANANT blue.

**Packing :** Individually cartoned at 30 Pcs./ct.

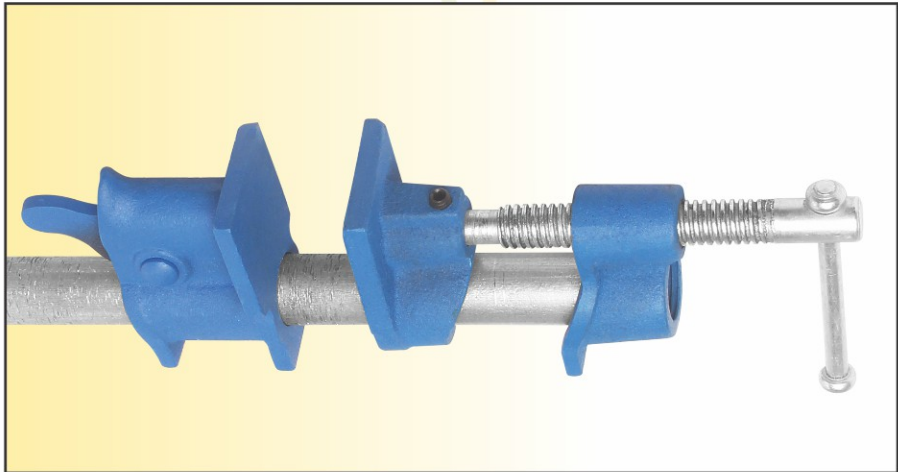

| Size | Price per Piece |
|------|-----------------|
| 1/2" | 466.00          |

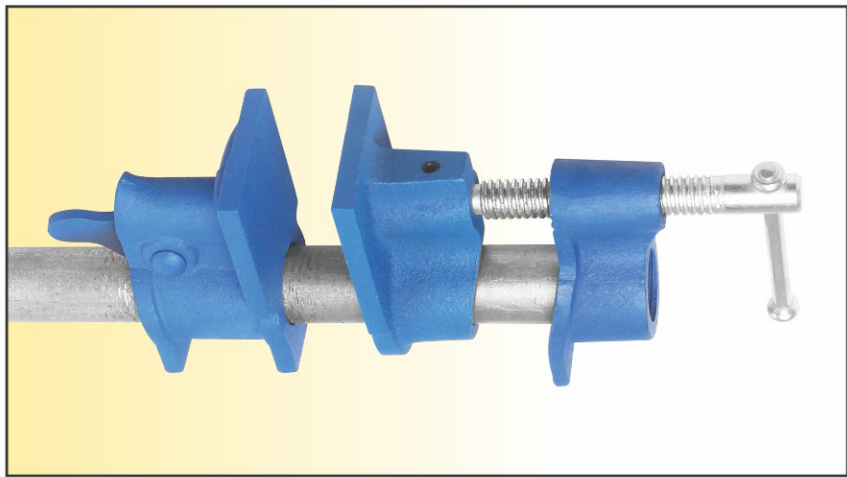

**Pipe/Gluing Clamp 3/4"**

**Description**

3/4" Heavy Duty Wood Gluing Pipe Clamp with quick release Carpenter Hand Tool. Easy to operate clamping force, sturdy and durable structure is simple, Spring lever control locks jaw at any needed location and provides quick release.

**Materials :**

Special Graded Iron.

**Fitting Pipe Size : 3/4"**

**Color:**

ANANT blue.

**Packing :** Individually cartoned at 16 Pcs./ct.

| Size | Price per Piece |
|------|-----------------|
| 3/4" | 513.00          |

## Steel Bodied F-Clamp

### Description

We are manufacturing a wide range of F- Clamp which is customized as per the specifications of our clients. These are special clamping equipment and are demanded as Industrial 'step-over' clamps. These are in compliance with various industrial standards and possess following specifications:



**Light Weight**



**Heavy Weight**

| Workable Length | Flat Size | Thickness | Rate    |
|-----------------|-----------|-----------|---------|
| 150             | 20        | 6         | 334.00  |
| 150             | 25        | 6         | 362.00  |
| 200             | 20        | 6         | 369.00  |
| 200             | 25        | 6         | 394.00  |
| 250             | 20        | 6         | 394.00  |
| 250             | 25        | 6         | 420.00  |
| 300             | 20        | 6         | 411.00  |
| 300             | 25        | 6         | 436.00  |
| 400             | 25        | 6         | 464.00  |
| 400             | 30        | 6         | 539.00  |
| 400             | 35        | 7         | 635.00  |
| 500             | 30        | 6         | 606.00  |
| 500             | 35        | 7         | 762.00  |
| 600             | 30        | 6         | 626.00  |
| 600             | 35        | 7         | 779.00  |
| 700             | 35        | 7         | 881.00  |
| 800             | 35        | 7         | 899.00  |
| 800             | 40        | 7         | 908.00  |
| 900             | 35        | 7         | 908.00  |
| 1000            | 40        | 7         | 950.00  |
| 1200            | 40        | 7         | 1131.00 |
| 1500            | 40        | 7         | 1267.00 |
| 2000            | 40        | 7         | 1609.00 |
| 2500            | 40        | 7         | 1962.00 |
| 3000            | 40        | 7         | 2234.00 |

| Workable Length | Flat Size | Thickness | Rate    |
|-----------------|-----------|-----------|---------|
| 150             | 20        | 6         | 369.00  |
| 150             | 25        | 6         | 429.00  |
| 200             | 20        | 6         | 446.00  |
| 200             | 25        | 6         | 453.00  |
| 250             | 20        | 6         | 453.00  |
| 250             | 25        | 6         | 480.00  |
| 300             | 20        | 6         | 480.00  |
| 300             | 25        | 6         | 507.00  |
| 300             | 30        | 6         | 549.00  |
| 400             | 25        | 6         | 531.00  |
| 400             | 30        | 6         | 617.00  |
| 400             | 35        | 7         | 685.00  |
| 500             | 30        | 6         | 685.00  |
| 500             | 35        | 7         | 754.00  |
| 600             | 30        | 6         | 694.00  |
| 600             | 35        | 7         | 729.00  |
| 600             | 40        | 7         | 762.00  |
| 700             | 35        | 7         | 762.00  |
| 800             | 35        | 7         | 908.00  |
| 800             | 40        | 7         | 942.00  |
| 900             | 35        | 7         | 917.00  |
| 1000            | 35        | 7         | 950.00  |
| 1000            | 40        | 7         | 1131.00 |
| 1200            | 40        | 7         | 1132.00 |
| 1500            | 40        | 7         | 1250.00 |
| 2000            | 40        | 7         | 1628.00 |
| 2500            | 40        | 7         | 1943.00 |
| 3000            | 40        | 7         | 2219.00 |

**ANANT HAND SAW**

**Description**

ANANT Professional and Universal Handsaw is most suitable for all types of wood and related material for Smoother finish and Faster Cut.

**Material**

High Quality Steel.

**Packing**

Packed 6 pcs. in one box and 8 boxes in one Cartoon.



**ANANT Handsaw Professional (Crosscut)**

with Rubber Grip ABS Soft Handle  
Ready to Use

| Size               | Price per Piece |
|--------------------|-----------------|
| <b>16" (410mm)</b> | 329.00          |
| <b>18" (450mm)</b> | 363.00          |
| <b>22" (560mm)</b> | 385.00          |

**ANANT Handsaw Universal (Push Type)**

Yellow PP & Black PVC Handle  
Ready to Use

| Size               | Price per Piece |
|--------------------|-----------------|
| <b>16" (410mm)</b> | 211.00          |
| <b>18" (450mm)</b> | 220.00          |
| <b>22" (560mm)</b> | 245.00          |

**ANANT Handsaw Universal (Pull Type)**

Yellow PP & Black PVC Handle  
Ready to Use

| Size               | Price per Piece |
|--------------------|-----------------|
| <b>16" (410mm)</b> | 211.00          |
| <b>18" (450mm)</b> | 220.00          |
| <b>22" (560mm)</b> | 245.00          |



**ANANT Combination & Sharpening Stone**

**Description**

ANANT Silicon Carbide Combination Stone is used for Sharpening Chisels, Plane Iron, Knives, and Blades etc. High Quality of Silicon Carbide Stone are best suitable for Sharp and Fast Cutting.

**Material**

High Quality Silicon Carbide.

**Packing**

Packed individual in a box and 50 pcs. in one Cartoon.

**ANANT Silicon Carbide Sharpening Stone**

Grit C120/C240

| Size              | Price per Piece |
|-------------------|-----------------|
| <b>6"x2.5"x1"</b> | 241.00          |
| <b>8"x2"x1"</b>   | 302.00          |

**ROTARY HAMMER A220**

**Description**

Bore 20 mm  
 Power 500 w  
 Max. Speed 850 rpm  
 Volt 220 v

| No.          | Price per Piece |
|--------------|-----------------|
| <b>A 220</b> | 4552.00         |



**ANANT ELECTRIC PLANER A 082**

**Description**

Width of Cutter 82mm  
 Cutting Depth 1mm  
 Frequency 50/60Hz  
 Input Power 710W  
 RPM 15000/Min.  
 Voltage 220V

| No.        | Price per Piece |
|------------|-----------------|
| <b>082</b> | 4837.00         |

**ANANT DRILL MACHINE (13MM)**

**Description**

Bore 13 mm  
 Power ??? w  
 Max. Speed ??? rpm  
 Volt 220 v

| No.           | Price per Piece |
|---------------|-----------------|
| <b>A 1303</b> | 2743.00         |



**ANANT Marble Cutter A110B**

Powerful Motor 1300w  
110mm Blade size.

ANANT Marble Cutter can be used for cutting Marble, Tile, Wood etc.

Comes with manufacturer warranty of 6 months, a Free Pair of Carbon Brush for a long tool life.

Soft Grip Handle to provide fatigue free working and Heavy motor to give you a long tool life.

| No.           | Price per Piece |
|---------------|-----------------|
| <b>A 110B</b> | 3284.00         |
| <b>A 1104</b> | 3050.00         |



**ANANT Angle Grinder A100**

Power 850w

The small angle grinders are powerful, handy tools from ANANT for working on metal.

- This ANANT angle grinder is an incredible all-round angle grinder.
- It is safe and easy to use helping you complete your job quickly and effortlessly.
- It has a small gear head for easy working giving you your money's worth.

| No.          | Price per Piece |
|--------------|-----------------|
| <b>A 100</b> | 2496.00         |
| <b>A 801</b> | 2790.00         |

**ANANT Reinforced Cut OFF Wheel**

107x1.2x16mm

**Description**

Super thin Cut off wheel

Max 15330 RPM

Max 80 M/S

For Cutting Inox, Metals, Sainless Steel

| Size         | Price per Piece |
|--------------|-----------------|
| 107x1.2x16mm | 20.00           |



## ANANT Rockstar Diamond Saw Blade SEGMENTED

### Description

ANANT Rockstar diamond saw blade is suitable for faster cutting & Longer Life for cutting of Marble, Granite, Bricks & Tiles on Dry surface.

Width of Cutter 110mm (Segmented)  
Bore 20mm  
Max. Speed 15000 RPM 80 M/S  
Diameter 4½"

|                 |
|-----------------|
| Price per Piece |
| 150.00          |

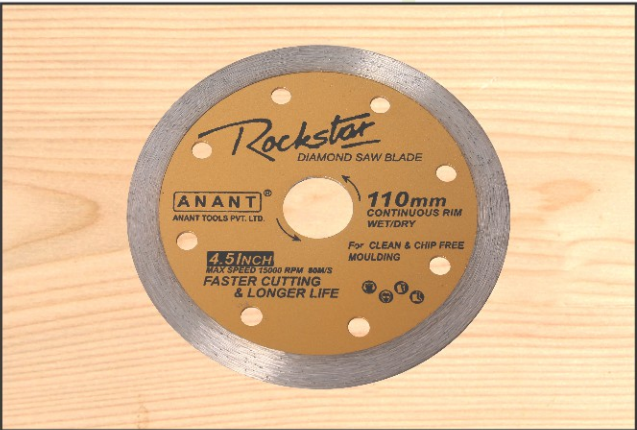
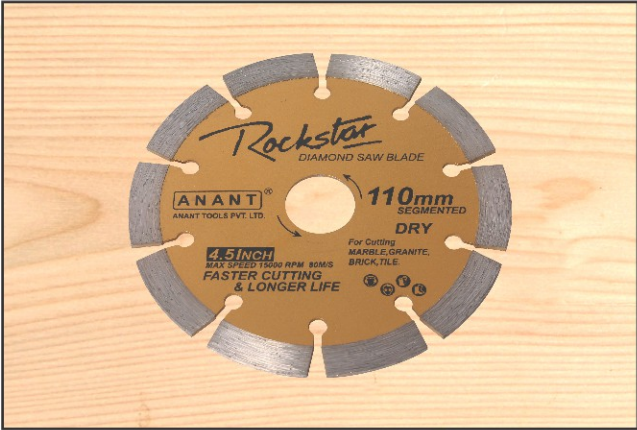

## ANANT Rockstar Diamond Saw Blade CONTINUOUS RIM WET/DRY

### Description

ANANT Rockstar diamond saw blade is suitable for faster cutting & Longer Life for cutting of Clean & Chip Free Moulding

Width of Cutter 110mm (Continuous Rim wet/dry)  
Bore 20mm  
Max. Speed 15000 RPM 80 M/S  
Diameter 4½"

|                 |
|-----------------|
| Price per Piece |
| 150.00          |

## ANANT Woodcraft TCT Circular Saw Blade

ANANT Woodcraft TCT Circular Saw Blade is suitable for cutting Wood, Plywood, Laminates, Chipboard Three times more faster.

### Description

Width of Cutter 110mm  
Bore 20mm  
Max. Speed 14000 RPM  
Diameter 4½"  
Teeth 40

| Diameter | Price per Piece |
|----------|-----------------|
| 4½"      | 260.00          |
| 5"       | 283.00          |



## ANANT Razor TCT Circular Saw Blade

ANANT Razor TCT Circular Saw Blade is suitable for cutting Wood, Plywood, Laminates, Chipboard. Three times more faster. The Green Electroplating absorbs the heat and is Rust proof.

### Description

Width of Cutter 110mm  
Bore 20mm  
Max. Speed 14000 RPM  
Diameter 4½"  
Teeth 40

| Diameter | Price per Piece |
|----------|-----------------|
| 4½"      | 276.00          |
| 5"       | 303.00          |

**GREEN ELECTROPLATED**

**Description**

ANANT cramp, though compact, light and easily portable, is extremely robust. The bevel gears ensure smoothness of operation and are totally enclosed thus being protected against damage and dirt. Spring loaded cams provide a rapid action and positive grip. Between operations the cramp may be quickly released from the joist.

**Material**

Body : SG Iron of guaranteed quality.

Shoe and Cams : Malleable Iron.

Handle, Screw and Bevel gears : High quality steel.

**Flooring Clamp ATMFC153**

**Finish**

Enamelled ANANT Blue.

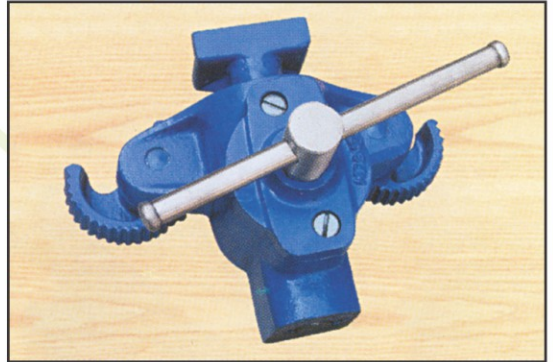

| No.           | Particulars   | Price per Pc. |
|---------------|---------------|---------------|
| <b>AM 153</b> | Flooring Camp | 5376.00       |

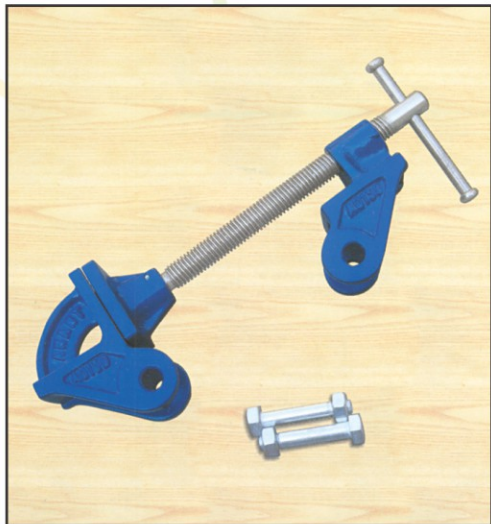

**Clamp Head AM130**

**Description** With a pair of ANANT Cramp heads, a bar cramp of any length can easily be made using a piece of timber 1 inch (26mm) thick.

Fitted with an improved working slide

**Materials**

Head and slides : Best quality cast iron.

Handle and screw : High quality steel.

**Finish**

Stove Enamelled ANANT Blue.

**Packing**

Individually packed in carton box.

| No.           | Particulars | Price per Pc. |
|---------------|-------------|---------------|
| <b>AM 130</b> | Clamp Head  | 952.00        |

**ANANT Carpenter Pincer**

Made by India's leading manufacturer of pliers, cutters for industry and professional craftsmen, our Carpenter's Pincers are forged using special tool steel and oil hardened. The plastic-coated, straight handles are offset from the pivot joint, which compounds the gripping force. Traditional tools used primarily for extracting fasteners, Carpenter's Pincers are designed to grasp, cut and pull an object with significant mechanical force. The smooth, polished face of the bullnose" head curves to a cutting edge that has been ground with minimal bevel. This design allows the very top of a nail to be grasped virtually flush with the surface, and effortlessly extracted with a very high degree of leverage. Even embedded or deformed nails are removed easily. With a hardened striking face, it is superbly suited for most construction, concrete, roofing, fencing and fabrication work.



|                 |        |
|-----------------|--------|
| Price per Piece | 147.00 |
|-----------------|--------|



#### **TERMS & CONDITIONS:**

1. Order will be subject to our confirmation.
2. Prices are ex-godown and subject to change without notice.
3. Goods & Service Tax extra.
4. Each tool is packed and dispatched after minute checking and as such is guaranteed.
5. 25% advance by demand draft with confirmed order and for balance payment, documents will be negotiated through nationalised bank only.
6. All payments even advance should be made direct to the company through M/O or payee's account cheques, company will not be responsible for any payment made to the agent.
7. In case of dispute, jurisdiction Jalandhar courts.

**GUARANTEE:** All ANANT products are manufactured under the strict supervision of qualified and experienced technicians. As such they are guaranteed for performance and any other manufacturing defects.

**REPLACEMENTS:** Any part claimed to be defective must be returned to us with transportation charges prepaid. The part will be replaced free of charge and the transportation charges refunded, if on examination the part is found defective in material or workmanship. In case no defect is found in the part, the same will be returned to the senders at their cost. Except this, there is no other guarantee for our products and no selling agents or representative of the company is authorised to make any change in our above guarantee and the term of replacement.